

## The Right Climate for Live Cell Imaging

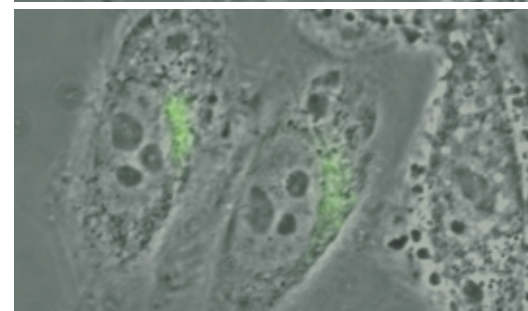
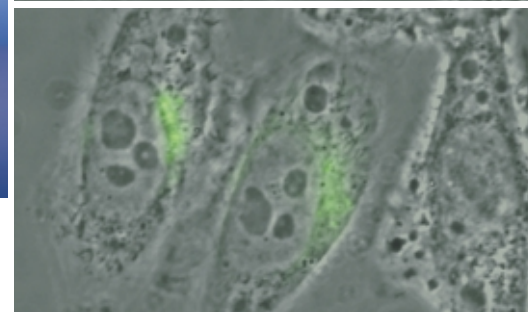
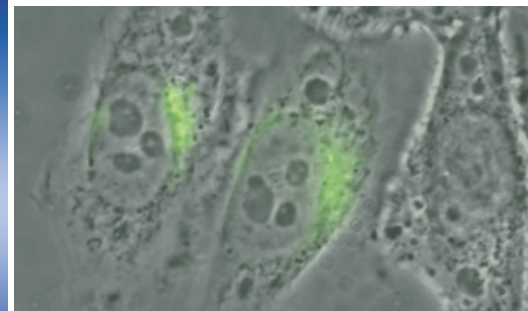
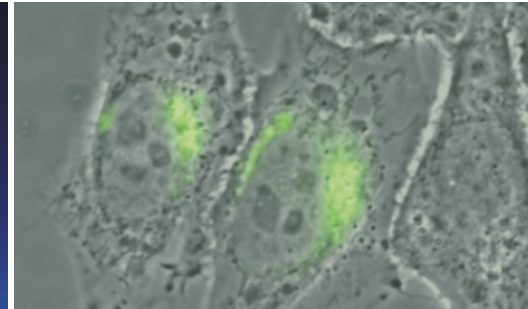
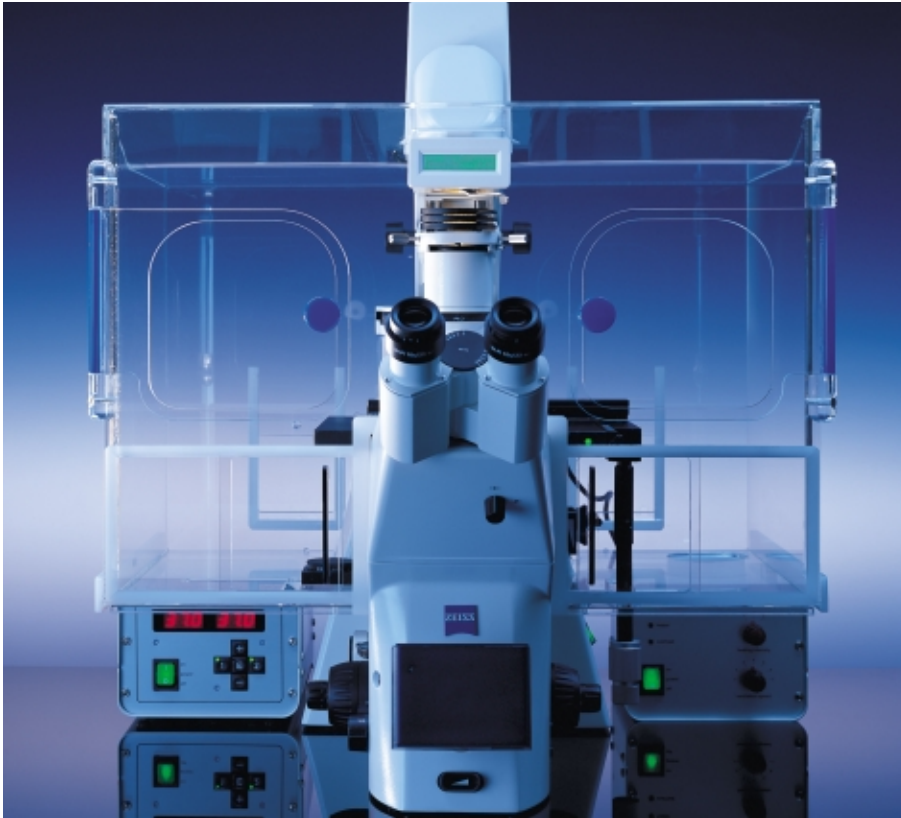

Modern methods of microscopy such as Live Cell Imaging offer innovative ways for qualitative and quantitative analyses in cell biology, molecular biology, physiology and biotechnology.

Cellular activities in cell, tissue or organ cultures can be examined in many different ways. Today complex structural and functional analyses of biological processes can be carried out experimentally even on a molecular level.

Typical parameters of cell biological processes are temperature, pH-value and O<sub>2</sub> concentration. Maintaining these parameters is essential for reproducible experiments and thus an important precondition for demanding experiments in the live sciences.

The modular system "Incubation on the Microscope" from Carl Zeiss offers a wide choice of individual components. Its building block principle offers maximum flexibility and permits the use of virtually every microscopical examination technique.

**Temperature, CO<sub>2</sub> and O<sub>2</sub> Control  
for Cell and Tissue Cultures  
under the Microscope**



# Axiovert 200: the new standard in inverted microscopy

Live cell imaging, micromanipulation of living cells – never before have such rigorous demands been placed upon stability, flexibility, reliability and operating comfort of microscopes. And never before has there been a microscope capable of meeting these demands so convincingly as the **Axiovert 200**.

## **Stability and Flexibility**

- Unmatched versatility of optical, mechanical and electronic interfaces
- Freedom to implement any system configuration
- Maximum flexibility for documentation: five documentation ports, four accept the dual video adapter

## **The Best Contrast: The New Fluorescence**

- Superb signal-to-noise ratio due to patented Carl Zeiss Light Trap
- New motorized shutter for specimen protection
- Enhanced image quality thanks to Köhler illumination in epi-fluorescence
- Five-place filter turret with a large 23 mm field of view, change cubes within seconds – just push & click

## **More Room for Better Results: The New Condensers**

- Longer working distances, important for convenient manipulation
- Freedom of choice from among the major contrasting techniques: DIC, Phase- or VAREL-contrast

## **Powerful Protection:**

- Aqua Stop: objectives and microscope stand are protected from spilled liquids by a patented triple protection system

## **More Comfort, Convenience and Control: The New Ergonomics**

- All controls, e.g. choice of documentation port, lamp voltage, etc., are conveniently arranged close to the focusing knobs
- Ergotube with ideal viewing angle and continuous height adjustment for every body height
- LCD display – digital display of status of all major functions
- Many practical innovations to make your work easier: Light Manager, Focus Stop, or DIC slider which can be operated from both sides

## **Motorized and Mighty: Axiovert 200 M**

- Automatic setting of objective and reflector turret position
- Automatic setting of previously selected diaphragm settings and brightness levels via the Light Manager
- Choice of 5 documentation ports
- Additional 1.6x and 2.5x magnification through motorized Optovar
- Push-button controlled fluorescence shutter and halogen lamp on-off switch
- Motorized Z-Focus with high-precision Harmonic Drive for Z-stacks

**Innovations to help you**

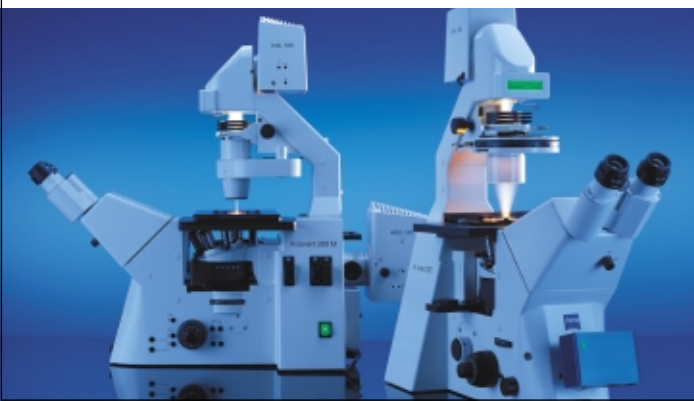

# Contents

<b>Introduction</b>	2–3
<b>Temperature control of specimen vessels / heating</b> (3°C above room temperature to max. 60°C) Heatable Mounting Frames (for inverted and upright microscopes), Heating Inserts, Heating Stages (for inverted and stereomicroscopes), Pre-Heating Plates, Temperature Control Units	4–9
<b>Temperature control of specimen vessels / cooling and heating</b> (0°C to max. 65°C) Temperable Insert, Temperable Stages (for inverted and stereomicroscopes), Temperable Plate	10–11
<b>Temperature control with warm air</b> (3°C above room temperature to max. 40°C) Incubators S, S-M, M, XL, Heating Unit	12–15
<b>Temperature control in the observation area below the specimen</b> Objective Heaters for oil and water immersion objectives, Temperature Control Units	16–17
<b>Controlling the pH-value in the specimen area using CO<sub>2</sub> incubation</b> Incubators S, S-M, M with CTI-Controller, Incubator XL with CO <sub>2</sub> Controller	18–19
<b>Increasing the relative humidity of the air</b> (in combination with incubators) Humidifier System for Incubators S, S-M, Humidifier Modules, Gas-permeable Membranes for Petri Dishes (Ø 35 mm & 60 mm), for POC-R Cell Cultivation System, for Multiwell Dishes	20–21
<b>Controlling the O<sub>2</sub> concentration</b> Incubation System O <sub>2</sub> –CO <sub>2</sub> –°C: O <sub>2</sub> -Controller, Heating Insert P, Incubator S, CTI-Controller, Tempcontrol 37-2 <i>digital</i>	22–23
<b>Cell cultivation systems</b> POC-R Cell Cultivation System, Open / Closed Perfusion, Multichannel Peristaltic Pump	24–25
<b>Frequently asked questions</b>	26–27
<b>Choosing the right components - Your guide for selecting the best</b>	28–32
<b>Axiovert 200: The new standard in inverted microscopy</b>	Inside front cover
<b>Cell Observer: The complete solution for Live Cell Imaging</b>	Inside rear cover

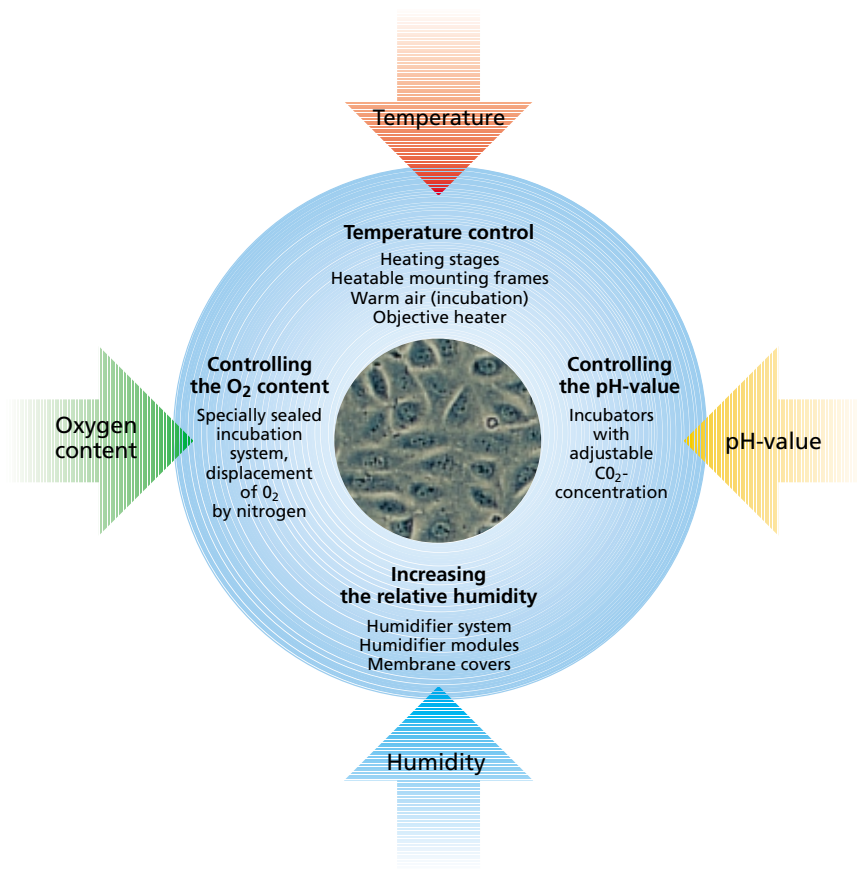

### Important for life: the temperature

Metabolic processes in cells are highly temperature dependent. Usually the body temperature of the examined species determines the temperature used for the experiment. For example, a temperature of 36.5°C – 37°C is usually used for cultured cells of warm-blooded animals. An exception are the cells of birds which are cultured at 38°C – 39°C. Cells of cold-blooded (ectothermal) animals are cultured at 15°C – 30°C taking their varying temperature into account. For certain experiments cultured mammalian cells must be briefly exposed to low temperatures, e.g. to avoid the fast movement of components of the cell membrane or generally, to slow down differentiation processes and proliferation. Also higher temperatures may be required, for example for activating proteins ("heat-shock").

The following components are available to provide stable temperature conditions on the microscope:

The simplest and most important way to achieve a constant temperature is the use of a heating stage. A wide selection of mounting frames for the diverse chambers is available. For temperatures lower than 3°C above ambient a temperable stage is available. It is combined with a circulator for the temperature regulation and circulation of liquids through the stage. It covers a temperature range from 0°C to + 65°C. Both types of stages are suitable for electrophysiological experiments since no interfering electric pulses are generated.

A further possibility of controlling the temperature is by blowing heated air across the specimen within a closed system (incubator). When used together with the heating stage or a heating insert it supplies the specimen with the necessary heat energy. At the same time, water condensation on the lid of the cell cultivation dish is avoided.

Heating of the objective will further improve the thermal condition in the observation area since a heated objective transfers heat to the specimen via immersion oil and glass.

To provide stable conditions for live cell experiments, the complete setup should be activated at least 30 to 120 minutes prior to the start of an experiment depending on the individual configuration.

### **Perfectly buffered: the pH value**

The pH-value in organisms is precisely controlled. The buffer system in blood ( $\text{CO}_2$ - $\text{NaHCO}_3$ ) keeps the pH-value constant at approx. 7.3 – 7.4. During in vitro cell cultivation the culture medium usually also contains  $\text{NaHCO}_3$  as a buffer in addition to amino acids, salts, vitamins and sera. In most cells a stable,  $\text{CO}_2$ -independent buffer such as Hepes, may cause changes in the cellular metabolism (membrane damage – ion channels) and thus can be toxic in higher concentrations. Of course the optimum pH-value of the culture medium may well differ between different cell lines. For example, transformed cells often display a higher proliferation rate at a lower pH-value of approx. 7.1 – 7.2.

The required  $\text{CO}_2$  concentration in the air of the microscope incubation system depends on the  $\text{NaHCO}_3$  content of the medium. Usually the same  $\text{CO}_2$  concentration is applied as the one used in the laboratory incubator.

### **Relative: the humidity of the air**

With rising temperature air can absorb more water. Some culture dishes such as Petri dishes or multiwell dishes, provide for a direct air exchange with the environment. Therefore, at  $37^\circ\text{C}$ , a greater amount of water will be extracted from the medium. As a result, the ion concentration in the nutrient increases and may reach toxic levels. Especially for long-term experiments it is necessary to increase the relative humidity. This is achieved by integrating a humidifier system or a humidifier module into the air circulation system.

For 35 mm and 60 mm Petri dishes, for the POC-R cell cultivation system and for Falcon® multiwell dishes, a gas permeable membrane cover ("FoilCover") is available. It consists of a 25  $\mu\text{m}$  thick membrane mounted in a metal frame. This membrane is permeable for gases ( $\text{CO}_2$ ,  $\text{O}_2$ ,  $\text{N}_2$ ) but impermeable for water molecules.

### **Less is more: the oxygen content ( $\text{O}_2$ )**

Often the oxygen concentration of the air, an important parameter, is not taken into account for cell cultivation. Ideally, the  $\text{O}_2$  concentration should be the same as in the living organism. Therefore, depending on the cell type, the oxygen content of the ambient air should be reduced from 20.8% to approx. 5%.

In addition to the  $\text{CO}_2$  and temperature control system, Zeiss also offers a device that reduces the oxygen concentration in the air through displacement with nitrogen. This requires an improved imperviousness of all components. Therefore the  $\text{O}_2$  control system is only available as a complete package.

### **The cell cultivation system**

High-performance microscopes, high-NA objectives and state-of-the-art optical techniques are essential tools for microscopic analyses of living cells. These are not usually available with routine microscopes. The POC-R cell cultivation and perfusion system meets all demands of live cell imaging and permits the use of all contrasting techniques.

Some of the studies that can be performed using the POC-R chamber system are:

- During time-lapse examinations: supplying the cells with fresh culture medium by perfusion during the observation time
- During tests on the influence of toxic and other substances: perfusion with interactive substances
- Functional analyses: for example, the signals of heart muscle cells in culture – frequency and amplitude – which react sensitively to changes in the environment.
- Complex dynamic analyses: time-lapse, multichannel and Z-stack series (LSM)



# Temperature control of specimen vessels / heating

(3°C above room temperature to max. 60°C)

Heating stage, heatable mounting frames and heating inserts are ideal for:

- **Routine observations**
- **Long-term imaging**
- **Analytical techniques**

Usually cells are cultivated at 37°C. But the temperature can be set to that of the individual living organism being studied.

The temperature is controlled with the Tempcontrol Unit.

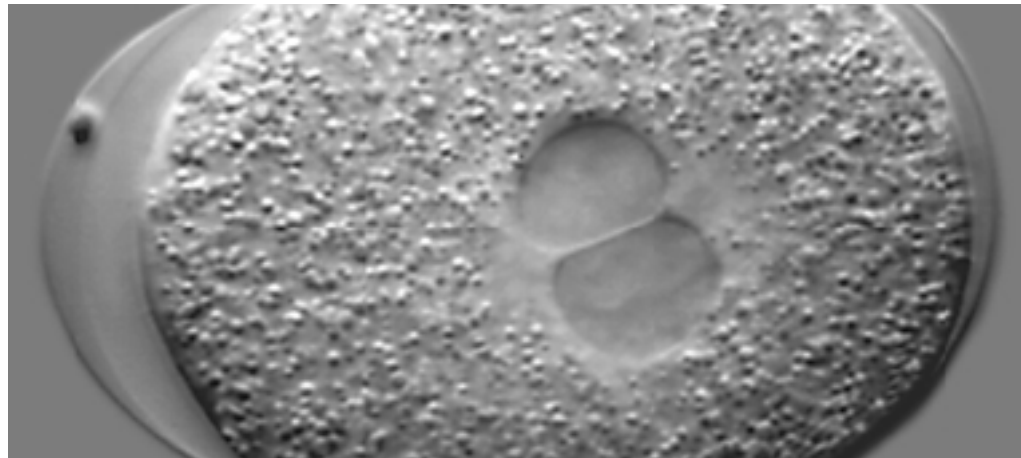

*C. elegans, Embryo, R. Schnabel, TU Braunschweig*

## Heatable Universal Mounting Frames

- Heatable mounting frames for various cell cultivation vessels and universal use
- Laminated plates provide for direct heating from below
- The specimen vessel is held by 2 sliding brackets which can be moved across the heated aluminum plate
- Adaptable temperature control on the microscope
- For use with object guide: heatable mounting frame M-H
- For use with mechanical stage and scanning stage: heatable mounting frames K-H and KH-L
- Recommended for use with dry objectives

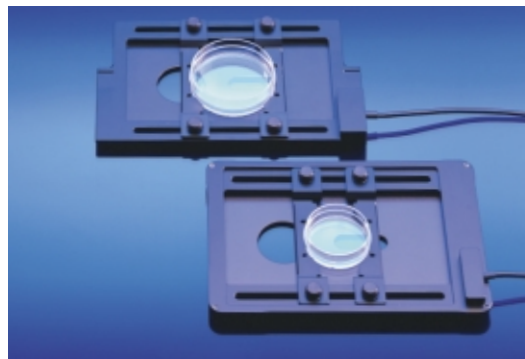

- Black, anodized aluminum
- Outer dimensions (LxW in mm) of heatable mounting frames:
 

M-H	165 x 100
K-H	160 x 110
KH-L	160 x 110
A-H	153 x 110
- Aluminum plate with laminated printed circuit board with circular opening (dia. 35 mm) and slot (30 x 10 mm), e.g. for 35 mm and 60 mm Petri dishes and POC-R; or rectangular hole (47 x 21 mm) particularly for use with Incubator XL
- Two adjustable sliding brackets

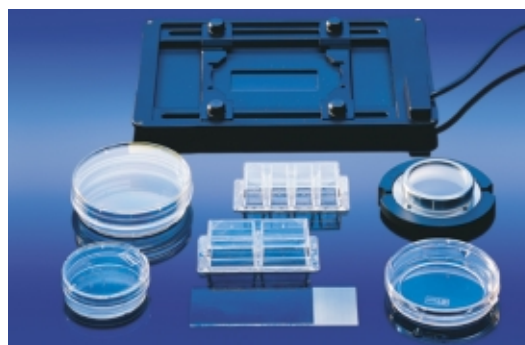

- Easily attached (like a standard mounting frame)
- For use with object guide: heatable universal mounting frame
 

M-H	Cat. No. 1116-064
-----	-------------------
- For use with mechanical stage and scanning stage: heatable universal mounting frames
 

K-H	Cat. No. 1116-056
KH-L	Cat. No. 1005-837

- Heatable mounting frame A-H for use with upright microscopes

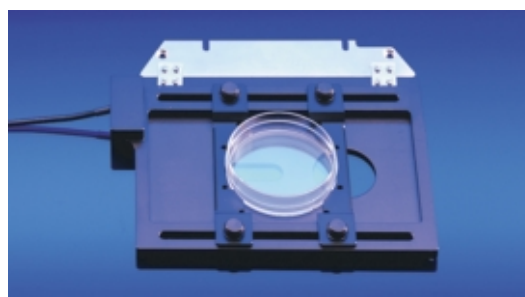

- Suitable for Axioplan and Axioskop upright microscopes: heatable mounting frame
 

A-H	Cat. No. 1116-055
-----	-------------------

### Heating Insert P

- Heating of the entire chamber block ensures optimum heat radiation for a uniform heat distribution throughout
- Ideal for work
  - with high magnification
  - with precise positioning
  - for LSM applications
  - live cell imaging
- Compatible with condensers 0.35 and 0.55
- Optimally dimensioned heated stage insert
- Specimens are firmly seated in the heating insert P
- Ducts permit installation of perfusion tubes for nutrient exchange, etc.
- Precise leveling with 4 screws (e.g. for long-term experiments at different stage positions)
- If required the observation window can be closed with a round cover glass (for objectives with long working distances)
- DIC-compatible cover with glass insert
- Cover during operation if no specimen vessel is used (during warming-up)
- No interfering switching pulses makes it suited for electrophysiological experiments
- Adapter ring for use of small Petri dishes (Ø 35 – 38 mm)
- Prepared for incubation with CO<sub>2</sub> control (incubator S)

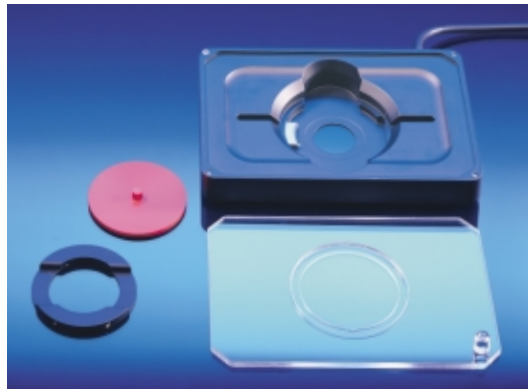

- Black, anodized aluminum, for use in mechanical stage and scanning stage
- Outer dimensions (LxWxH in mm): 160 x 110 x 18 (+4), as mounting frame K for mechanical stage
- Power consumption: ca. 8 W at 37°C
- 8-pin connection cable to Tempcontrol Unit
- Heating is performed through transistor power dissipation
- Observation area: central opening Ø 32 x 30 mm (compatible with C-Apochromats)
- Petri dishes are held in position with spring clamp (Ø 52 to 58 mm)
- 2 ducts for perfusion tubings on the right and left, closed with Allen screws
- 4 slotted screws at the corners of the heating insert
- Included accessories:
  - Adapter ring with 4 screws for Petri dishes Ø 35 mm
  - Cover glasses, Ø 35 mm, 25 pcs.
  - Acrylic glass cover with central glass insert (DIC)
  - Red plastic insert (used during warming-up)
- Compatible with incubator S
- Weight (kg): 0.970
- Cat. No. 411861-9901

### Suitable cell culture chambers

- 60 mm Petri dishes (Ø 52 to 58 mm)
- 35 mm Petri dishes (Ø 35 to 38 mm) with adapter
- POC-R cell cultivation system (Ø 58 mm) with perfusion possibility
- LabTek and Falcon® chambered slides
- Microscope slides

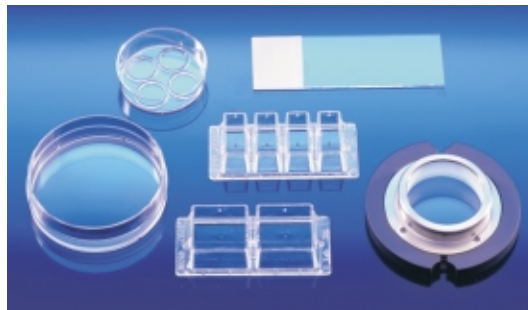

## Heating Inserts M06, M12, M24, M96

- For the simultaneous monitoring and imaging of multiple, time-dependent events under full environmental control, and for capturing time-lapse sequences
- Special heating inserts for Falcon® multiwell dishes
- Observation in multiwell dish applications in Live Cell Imaging and time lapse experiments
- Ideal for computer-controlled observation using multiwell dishes on the scanning stage
- Laminated heating plates ensure direct heating from below
- Setscrew permits optimum seating of the multiwell dishes in the heating insert
- Flexible system for temperature control of multiwell dishes on the microscope
- M06 Falcon® 6-well multiplate
- M12 Falcon® 12-well multiplate
- M24 Falcon® 24-well multiplate
- M96 Falcon® 96-well multiplate
- Prepared for CO<sub>2</sub> control
- FoilCover for multiwell dishes:  
(see page 21)

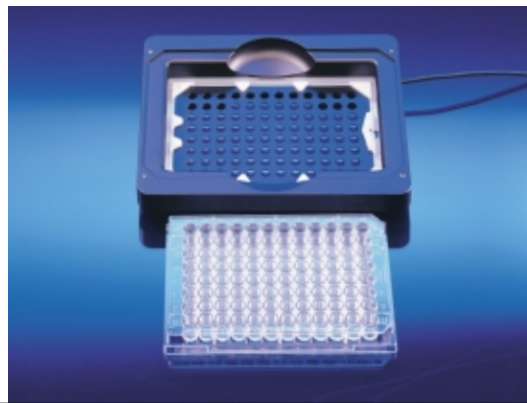

- Aluminum plate with laminated printed circuit board with circular openings of defined diameter
- Observation window diameter per well in the multiwell dishes of heating insert  
M06: dia 22 mm  
M12: dia 22 mm  
M24: dia 15.5 mm  
M96: dia 6 mm  
(M06 with reduced diameter of observation window for thermotechnical reasons)
- Plastic set screw
- Easy to insert into mechanical stage
- Compatible with mechanical stage and scanning stage
- Compatible with incubator S-M
- Weight (kg): 0.37

### Heating Insert

- M06 Cat. No. 1116-050
- M12 Cat. No. 1116-051
- M24 Cat. No. 1116-052
- M96 Cat. No. 1116-053



### Heating Stage for the Axiovert 200

- Universal heating stage for all commonly used culture vessels
- Solid design
- Suitable for all standard observation techniques
- No interferences due to electric pulses, therefore ideal for electrophysiological experiments
- Optimal heat transfer through the stage plate with smallest possible opening for the objective
- Prepared for CO<sub>2</sub> control
- Retrofittable for future long-term life cell imaging experiments

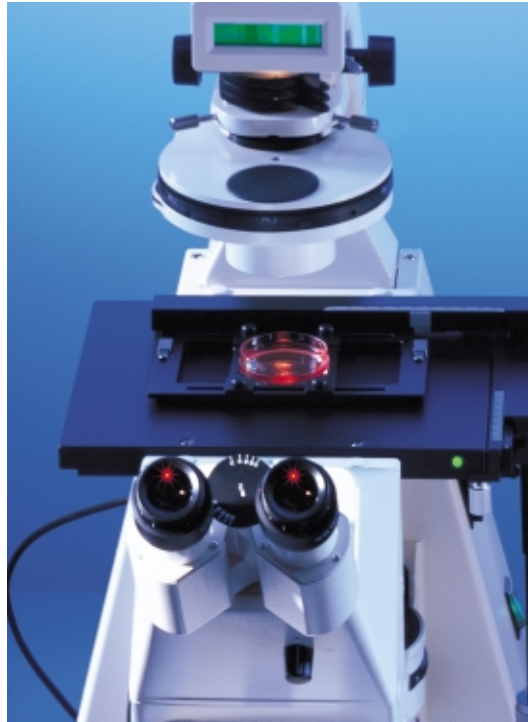

- Stage plate (aluminum), black, anodized
- Dimensions identical to Axiovert stage plate (LxWxH in mm): 250 x 230 x 18
- 3-point stage support with adapter
- Object guide and micromanipulators can be attached on the left or right, as required
- Heating is performed through transistor power dissipation
- Temperature stability: +/- 0.1°C
- Power consumption: 10 W at 37°C
- 24 V Protective low voltage
- Self-resetting over-temperature cut-out switch
- Green LED display at the right front of the stage
- 8-pin cable connection to the Tempcontrol unit
- Tubing nozzle for air pump tubing, and air exit slits in the objective channel
- Oval stage opening with dia. 25 mm
- Compatible with Incubator M for Axiovert 200 Incubator XL for Axiovert 200
- Cat. No. 1116-048

### Option: Air Circulation Generator for the Heating Stage

- Simple and cost-efficient temperature optimization at the site of observation (objective, optical axis)
- A warm air curtain prevents heat dissipation

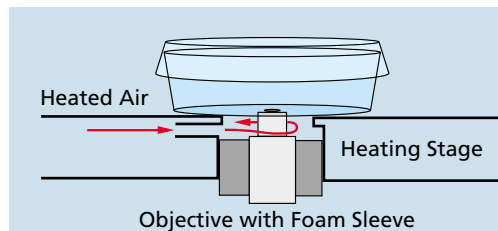

- Air is pumped into the heating stage (tubing inlet is at the bottom of the stage) and is heated to stage temperature
- Air exits through 2 slits in the stage opening near the objective, creating a warm air curtain under the observation area
- Accessories: double diaphragm pump, silicone tubing, polystyrene foam sleeves for objectives
- Air circulation generator
- 230 V Cat. No. 471824
- 110 V Cat. No. 471823

### **Pre-Heating Plate, Pre-Heating Plate with 3 Inserts**

- Temperature control of specimens which must be available directly near the microscope
- Temperature control of specimens in the laminar air flow with receptacles for flasks, centrifuge tubes and reaction vessels

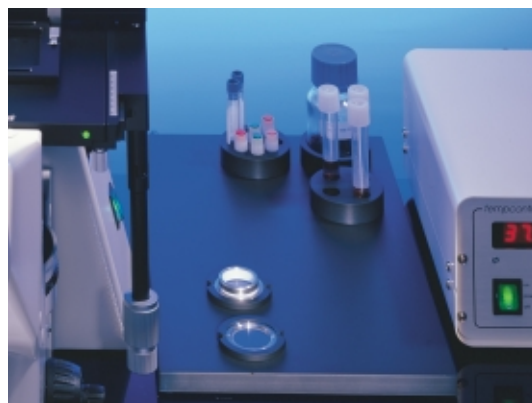

• For technical specifications see heating stage (page 7)

• Green LED display

*Pre-heating plate, small*

• Dimensions (LxWxH in mm): 210 x 160 x 15

• Weight (kg): 1.2

• Cat. No. 471841-9902

*Pre-heating plate with 3 inserts*

• Dimensions (LxWxH in mm): 250 x 400 x 16

• Plus 3 receptacles (inserts) for flasks, reaction vessels and centrifuge tubes

• Weight (kg): 4.3

• Cat. No. 1116-049

### **Heating Insert for Universal Transmitted Light Illumination**

- For stereomicroscopes
- Temperature control of specimen vessels
- Light filters (Ø 32 mm) can be inserted
- 2 adjustable brackets permit secure mounting of different types of chambers
- Specimen chambers: e.g. Petri dishes (Ø 30 mm to 105 mm) and other vessels



• For technical specifications see heating stage (page 7)

• Replaces glass plate of the transmitted light illumination S

• Central round opening Ø 25 mm

• 1 filter (Ø 32 mm, 2 mm thick) can be inserted into the top opening and up to 2 from below, fixed with an o-ring

• Specimen vessels are firmly held by two adjustable brackets

• Dimensions (LxWxH in mm): 210 x 160 x 15

• Weight (kg): 1.2

• Cat. No. 411862-9901

## Temperature control instruments (Tempcontrol) Electrical supply of the heating devices

### Tempcontrol 37 (1-channel)

- Analog control unit
- Adjustable nominal temperature (from 3°C above room temperature to max. 60°C)
- Control accuracy:  $\pm 0.1^\circ\text{C}$



- Electrical supply for the heating stage, heatable mounting frames, heating unit, heating insert P, heating insert M, heating insert for transmitted light illumination S and the CTI-controller
- Single channel operation
- Linear PID control
- Line connection: 110 / 230 V
- Power consumption: 90 VA
- Protective low voltage: 24 V
- Dimensions (LxWxH in mm): 200 x 175 x 138
- Weight (kg): 3.8
- Cat. No. 1116-057

### Tempcontrol 37-2 digital (2-channel)

- 2 heating devices can be operated independently from each other and with different nominal temperatures (from 3°C above room temperature to max. 60°C)
- Display of actual temperatures in °C of both channels (resolution 0.1°C) or, at the touch of a button, of the nominal temperatures
- The nominal temperatures are retained when the control unit is switched off
- The ventilator switches on automatically when the temperature in the control unit rises above a safe limit
- Permits external temperature control via a PC (software for Windows 3.1, 95 & 98 and RS 232 cable included)



- Electrical supply for the heating stage, heatable mounting frames, heating unit, heating insert P, heating insert M, heating insert for transmitted light illumination and the CTI-controller
- 2-channel operation: two heating channels can be activated separately, with individual nominal values
- Linear PID control
- Digital temperature display in a multifunction display
- Temperature-controlled ventilator
- Serial interface RS 232
- Line connection: 110 / 230 V
- Power consumption: 200 VA max.
- Protective low voltage: 24 V
- Dimensions (LxWxH in mm): 270 x 175 x 138
- Weight (kg): 5.0
- Cat. No. 1052-320

# Temperature control of specimen vessels / cooling and heating

(0°C to +65°C)

Temperature control from 0°C to + 65°C without interfering switching pulses using circulated water or other liquids.

Usually used for cooling.

Temperature control via an external circulator. Temperatures below approx. +10°C require the use of a dehumidifier or/and of dried air (to prevent condensation).



*Micromanipulation, Blastocyst, K. Vintersten, S. Gray, EMBL Heidelberg*

## Temperable Microscope Stage, Temperable Plate

- Universal temperature controlled stage for all commonly used culture vessels
- Stable design
- Suitable for all standard observation techniques
- Interfering electric pulses are avoided, therefore ideal for electrophysiological experiments
- Optimal temperature transfer through the stage plate with smallest possible opening for objective



### *Temperable microscope stage*

- Stage plate (aluminum) black, anodized
- Dimensions (LxWxH in mm): 250 x 230 x 18
- 3-point support with adapter
- Oval stage opening, Ø 25 mm
- Inlet and outlet openings for liquids
- Object guide and Eppendorf micromanipulator can be attached either on the right or left side
- Cat. No. 1116-066

### *Temperable plate*

- Outer dimensions (LxWxH in mm): 210 x 160 x 15
- Weight (kg): 1.2
- Cat. No. 1116-067

## Temperable Insert for Universal Transmitted Light Illumination

- For stereomicroscopes
- Temperature control of specimen vessels
- Light filters (Ø 32 mm) can be inserted
- 2 adjustable brackets permit the secure mounting of different vessels
- Specimen vessels, e.g. Petri dishes (Ø 30 mm to 105 mm) and other vessels



- Stage plate, black, anodized aluminum
- Outer dimensions (LxWxH in mm): 210 x 160 x 15
- Replaces glass plate of the transmitted light illumination S
- Central round opening Ø 25 mm
- 1 filter (Ø 32 mm, 1 mm thick) can be inserted into the top opening and up to 2 from below, fixed with an o-ring
- Specimen vessels are firmly held by two adjustable brackets
- Weight (kg): 1.2
- Cat. No. 411883

### Temperable Insert P

- Heating of the entire chamber block ensures optimum heat radiation for a uniform heat distribution throughout
- Ideal for work with high magnification, with precise positioning, for LSM applications, live cell imaging
- Compatible with condensers 0.35 and 0.55
- Useful diameter of heating energy stage
- Specimens are firmly seated in the temperable insert P
- Exact leveling possible (e.g. long-term experiments at different positions in the specimen)
- If required, observation opening can be closed with a round cover slip (objectives with a long working distance)
- DIC-compatible cover with glass insert
- Cover during operation if no specimen vessel is used (during warming-up)
- No interfering switching pulses in electrophysiological examinations
- Adapter ring for use of small Petri dishes (Ø 35 to 38 mm)
- Prepared for incubation with CO<sub>2</sub> control

#### Suitable specimen vessels

- 60 mm Petri dishes (Ø 52 to 58 mm)
- 35 mm Petri dishes (Ø 35 to 38 mm) with adapter
- POC-R cell cultivation system (Ø 58 mm) with perfusion possibility
- LabTek and Falcon® chambered slides
- Microscope slides

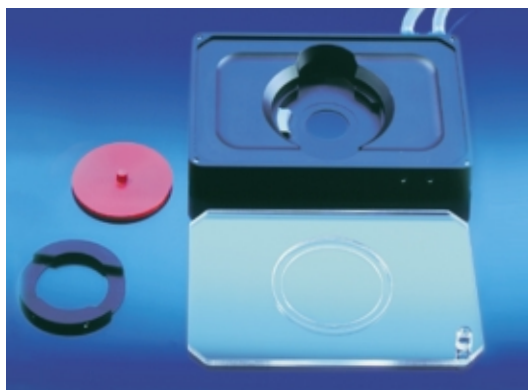

- Stage plate, black, anodized aluminum
- Dimensions (LxWxH in mm): 160 x 110 x 18 (+4), as "mounting frame K" for mechanical stage
- Compatible with mechanical stage and scanning stage
- Observation surface, central opening Ø 32 x 30 mm (compatible with C-Apochromats)
- 4 slotted screws at the corners of the heating insert
- Petri dishes are held in position with spring clamp (Ø 52 to 58 mm)
- 4 slotted screws at the corners of the heating insert
- Included accessories:
  - Adapter ring with 4 screws for Petri dishes Ø 35 mm
  - Cover glasses, Ø 35 mm, 25 pcs.
  - Acrylic glass cover with central glass insert
  - Red plastic insert (used during warming-up)
- Compatible with incubator S
- Weight (kg): 0.7
- Cat. No. 411882

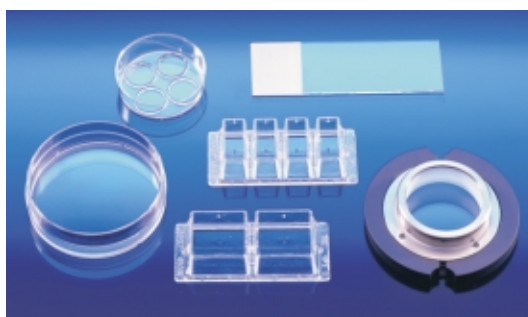

### Cooling Thermostat RE 106 (230V)

- Use of various cooling agents



- For the temperable stage, temperable plate, temperable insert P and temperable insert for transmitted light illumination
- Circulation thermostat consisting of the following components:
  - Pump
  - Cooling aggregate
  - Temperature display
  - Control and safety units
  - Container with cooling agent
- Recommended operating range: 0°C to +65°C
- Temperature control accuracy: +/- 0.05°C
- Cat. No. 1116-068
- Also available for 115 V



# Warm Air Incubation

(3°C above ambient to max. 40°C)

Transparent environmental chambers (Incubators) suitable for the following experiments:

- Long-term experiments of living cells
- Time-lapse imaging experiments for the examination of cell mobility and cell death
- Micromanipulation of living cells in temperature-controlled conditions

## Method of operation:

The incubator housing is attached to a heating stage or a heating insert. The temperature of the circulating air is controlled by the Tempcontrol electrical supply unit and a heating unit. Incubator XL functions without air circulation, the air is filtered prior to heating.

## The benefits:

- Temperature range from 3°C above room temperature to max. 40°C
- Attaching the incubator housing is simple and does not require tools

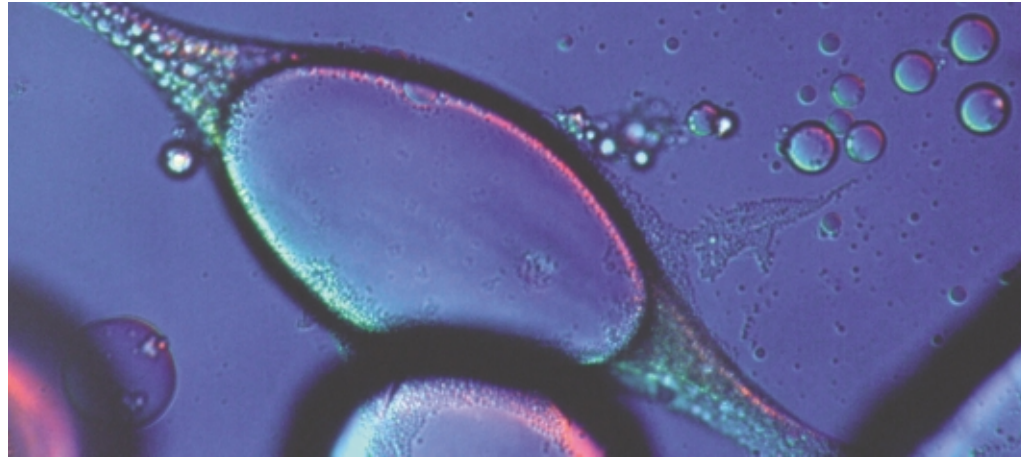

*Color play of a human fat cell,  
S. Pentz, Ulm*

## Warm Air Supply with Heating Unit

- The air circulation speed can be set according to the incubator used



- Warm air supply for incubators S, M, S-M and XL
- Air circulation speed adjustable in 7 steps
- Line connection: 110 V / 230 V
- Power consumption: 280 VA
- Dimensions (LxWxH in mm): 200 x 175 x 138
- Weight (kg): 4.2
- Cat. No. 1116-061

### Incubator S

- Cover with glass plate permits observation in DIC
- Conditioned air current can be diverted into a bypass channel when the cover is opened, i.e. the air composition is retained also during cell manipulation, during a change of the medium, etc.
- For tissue culture dishes, please see heating insert P on page 5
- Compatible with condensers 0.35 and 0.55



- Special low-volume acrylic glass housing (21 mm high), used together with the heating insert P
- Includes 2 interchangeable covers for closing the observation chamber:
  - one entirely made of acrylic glass, and
  - one with a central glass plate to permit observations in DIC
- Integrated bypass system
- Weight (kg): 0.6
- Cat. No. 411860-9902

### Incubator S-M

- Conditioned air current can be diverted into the bypass channel when the cover is opened, i.e. the air composition is retained also during cell manipulation, during a change of the medium, etc.
- For specimen vessels, please see heating inserts M06, M12, M24, M96 (see page 6)
- Compatible with condenser 0.35 only
- Used with LD-objectives



- Special low-volume transparent acrylic glass housing with a low height in the observation area, used with mechanical or scanning stage together with heating inserts M06, M12, M24, M96
- 1 removable cover, acrylic glass
- Integrated bypass system
- Weight (kg): 0.6
- Cat. No. 1116-060

### Incubator M

- Optimal solution for single side micromanipulation
- Can be used with the object guide mounted at the right side (right-left reversed version on request)
- Small air volume to be heated
- Compatible with Eppendorf micromanipulator InjectMan (Eppendorf Cat. No. 5179 000.018) with Axiovert 200 microscope adapter (Eppendorf Cat. No. 5171 141.003)
- Compatible with all condensers (except motorized versions)

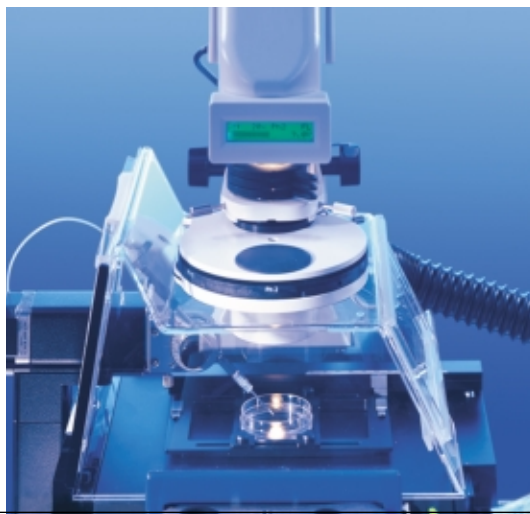

- Transparent acrylic glass housing, mounted on the heating stage with object guide attached to the right
- Small volume of the incubator housing
- Inner dimensions (LxWxH in mm): 220 x 250 x 130
- Slider opening on the right side
- Slider opening on the left side
- When using a manipulator the opening is sealed by a plastic bag with Velcro strip closure
- Right-left reversed version on request
- Weight (kg): 1.2
- Cat. No. 1116-058
- Observation area slightly reduced when used with Multiwell dishes

## Incubator XL

- Universal incubator encloses all components
- The temperature of entire space within the incubator housing incl. the area around the nosepiece is controlled. This provides for the most uniform warm air environment
- Assembly can be performed by the user
- Large doors permit easy access to the specimen, condenser, manipulators or other components mounted above the stage
- Sliding doors permit the easy operation of microscope components below the stage, change of reflector turret, etc.
- Slide-in floor panels provide for individualized use of stage controls on left or right
- All tissue culture chambers can be used without any restriction
- Objective heater or warm air curtain (air circulation generator) are not required



- Large transparent acrylic glass housing optimized for use with multiple and diverse components
- Inner dimensions (LxWxH in mm): ca. 600 x 370 x 380
- Compatible with fluorescence equipment, many stages and micro-manipulators (see examples on page 15)
- Easy assembly, no tools required
- 2 large doors above microscope stage
- 2 sliding doors below the microscope stage level
- Bottom panels (left, right) with openings for stage drives
- Minor restriction of the mechanical stage in the y-axis
- Weight (kg): 5.0
- Cat. No. 1116-059

**Examples for the  
universal use  
of the Incubator XL**

**with Scanning Stage  
DC 120 x100**

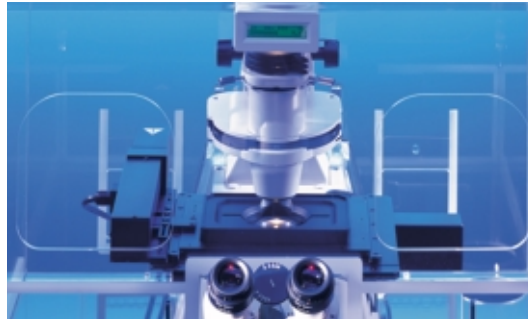

• *Cat. No. 1113-509*

**with mot.  
Micromanipulator DC6**



• *Cat. No. 1103-261 (left version)*  
• *Cat. No. 1103-262 (right version)*

**with Narishige  
Manipulators**



• *Cat. No. 1122-014*  
*1122-150*  
*1122-019*  
*1122-020*  
*1122-017*

**with Eppendorf  
Manipulator TransferMan**

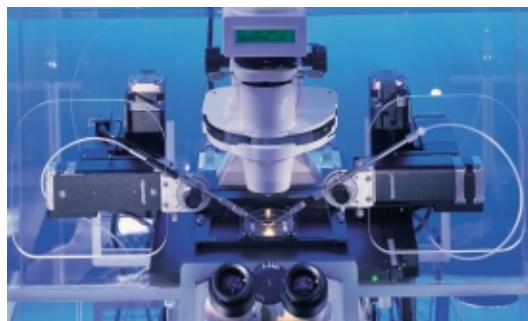

• *Cat. No. 5178.000.014 (Eppendorf)*

**with Eppendorf  
Manipulator InjectMan**



• *Cat. No. 5179.000.018 (Eppendorf)*



# Temperature control in the observation area below the specimen

Particularly when using oil immersion objectives, much heat may be lost through the objective. An objective heater improves the temperature stability and eliminates temperature gradients in the observation area.

Objective heaters consist of a black, anodized aluminum ring with a laterally mounted housing containing the heating elements (transistors) and the temperature sensor.

Any Tempcontrol unit can be used for the electrical supply and control. However, the Tempcontrol-mini is designed specifically for objective heaters. It provides for a control range of 35°C – 40°C.

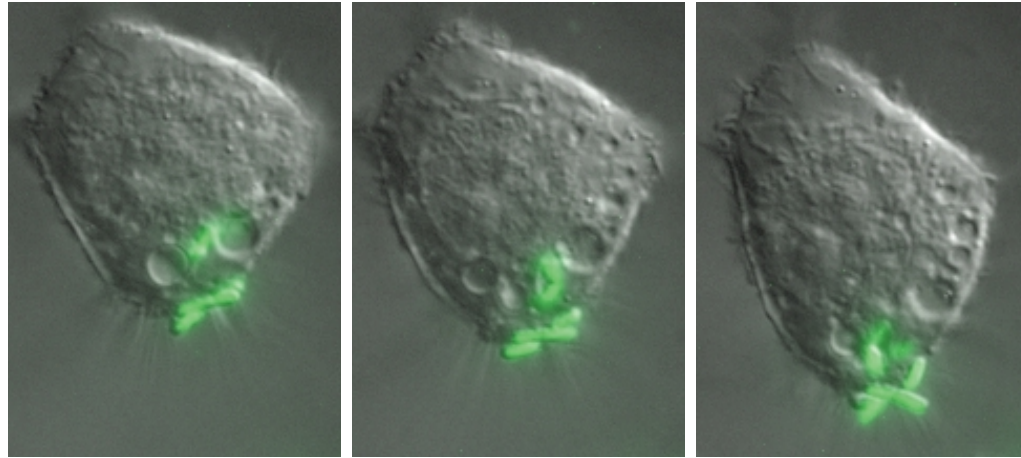

*Y. pestis, J. B. Bliska, SUNY Stony Brook*

## Polystyrene-foam sleeves

- Simple and practical method of protecting the lower specimen area from loss of heat

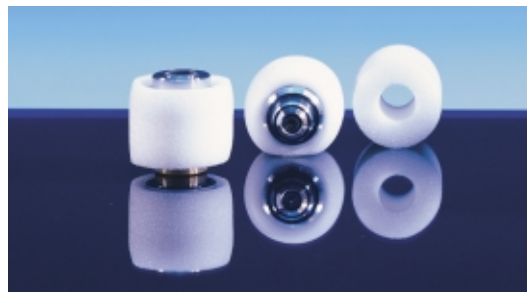

- Included as standard accessories with the heating stage, heatable mounting frames and temperable microscope stage

## Temperature control unit Tempcontrol-mini

- Control range: 35°C – 40°C



- Electrical supply for all three objective heaters
- Line connection: 110 – 230 V
- Power consumption: 20 VA
- Protective low voltage: 24 V
- Dimensions (LxWxH in mm): 210 x 105 x 73
- Weight (kg): 1.35
- Cat. No. 1116-070



### Objective Heater Ø 22.5 mm

Special feature: oil drain channel

Suitable for the objectives:

- Fluar 40x/1.30 Oil  
# 440255-9901-000
- Plan-Neofluar 40x/1.30 Oil  
# 000000-1022-818
- Plan-Neofluar 63x/1.25 Oil  
# 440460-0000-000
- Plan-Apochromat 63x/1.40 Oil  
# 440760-0000-000
- Plan-Apochromat 100x/1.40 Oil  
# 440780-0000-000
- Plan-Neofluar 100x/1.30 Oil  
# 000000-1018-595

Note: also suitable for Phasecontrast- and DIC-variants of the objectives mentioned above



- Objective heater for use with objectives with a front barrel of Ø 22.5 mm
- Cat. No. 1116-073

### Objective Heater Ø 17.5 mm

Special feature: oil drain channel

Suitable for the objectives:

- Achroplan 50x/0.90 Oil  
# 440057-0000-000
- Achroplan 100x/1.25 Oil  
# 440080-0000-000
- Fluar 100x/1.30 Oil UV  
# 440285-0000-000

Note: also suitable for Phasecontrast- and DIC-variants of the objectives mentioned above



- Objective heater for use with objectives with a front barrel of Ø 17.5 mm
- Cat. No. 1116-076

### Objective Heater for Water Immersion Objectives

Special feature: can be used on upright microscopes

Suitable for the objectives:

- Achroplan 40x/0.80 W  
# 440090-9901-000
- Achroplan 100x/1.0 W  
# 440087-0000-000



- Objective heater for water immersion objectives with a front barrel of Ø 17.0 mm
- Cat. No. 1116-075

# Control of the pH-value in the specimen area with CO<sub>2</sub> incubation

The CO<sub>2</sub> concentration in the ambient air directly influences the pH-value of media containing NaHCO<sub>3</sub>. For the control of the pH-value during incubation the desired CO<sub>2</sub> concentration is set on the CO<sub>2</sub>-Controller or the CTI-Controller.

An infrared CO<sub>2</sub> sensor constantly monitors the CO<sub>2</sub> concentration and automatically adds CO<sub>2</sub> as necessary. The CO<sub>2</sub> concentration is digitally displayed.

An existing warm-air incubation system is simply upgraded using one of the following components.

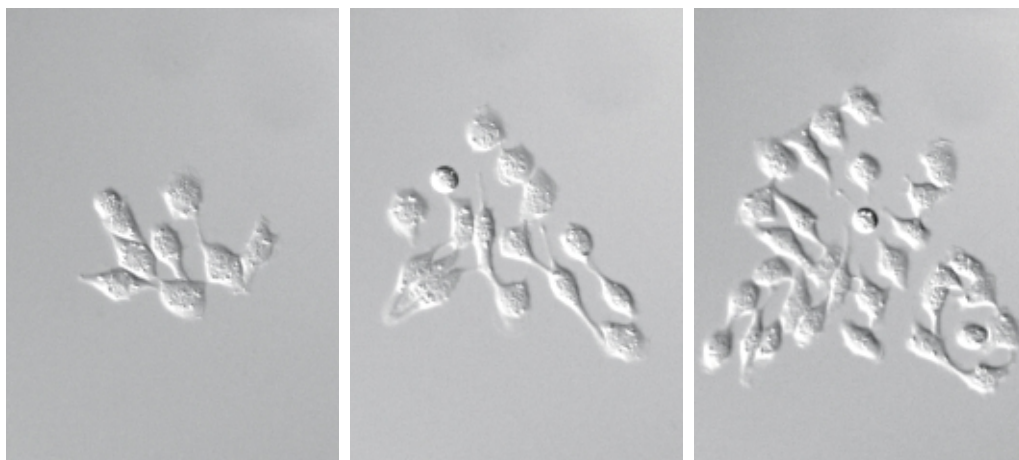

V79 Cells, Chinese Hamster, S. Pentz, Ulm

## CO<sub>2</sub>-Controller

- A pump directs a defined, controlled CO<sub>2</sub>-air mixture to a mini-incubator (see example 10, page 32)
- Humidifier module (1) to optimize the humidity of the air included (see page 20)



- CO<sub>2</sub> control via IR sensor, as with the CTI-controller
- RS 232 interface
- Compatible with incubator XL
- Integrated humidifier module (1), i.e. air humidity at 37°C increased to ca. 50 – 70 %
- Power consumption: 30 VA
- Dimensions (LxWxH in mm): 200 x 175 x 138
- Weight (kg): 7.35
- Cat. No. 1116-062

## CO<sub>2</sub> Cover (Mini-Incubator)

- Included with the CO<sub>2</sub>-controller
- Compatible with heatable mounting frame KH-L in combination with the mechanical stage or the scanning stage
- Optionally special CO<sub>2</sub> covers are available on request for heatable mounting frame M-H, for heating insert P or heating insert M
- DIC compatible



## Inkubator XL

The CO<sub>2</sub>-Controller is compatible for use with Incubator XL



For technical details, please see page 14

### CTI-Controller

- Control of temperature and CO<sub>2</sub> in one instrument
- Air circulation speed can be matched to the requirements (e.g. low speed when used with incubators S and S-M)
- Stable and reliable control



- Air circulation speed adjustable in 5 steps
- CO<sub>2</sub> control range: 0 – 7.5 %
- CO<sub>2</sub> control accuracy: 0.1 % after setting of an adequate CO<sub>2</sub> pressure
- CO<sub>2</sub> supply can be switched off
- Digital CO<sub>2</sub> display in a multifunction display unit
- RS 232 interface
- Compatible with incubators S, S-M, M
- Air humidity: see humidifier system
- Power consumption: 80 VA
- Dimensions (LxWxH in mm): 270 x 260 x 185
- Weight (kg): 10.74
- Cat. No. 411856-9903

### Incubators S, S-M, M

The CTI-Controller is compatible with incubators S, S-M and M

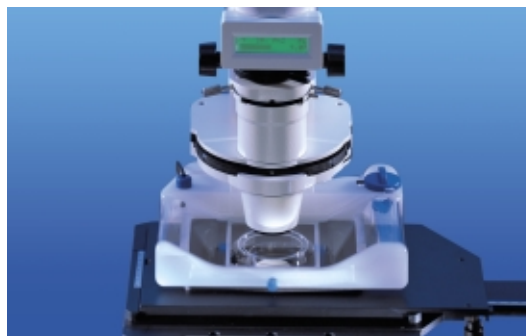

For technical details,  
please see page 13

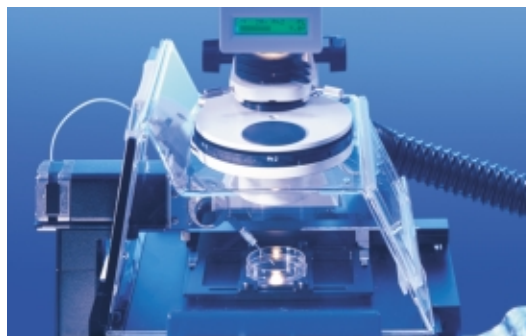

# Increasing the humidity of the air (in combination with incubators)

With increasing temperature, air absorbs a greater volume of water. Therefore an increasing amount of water will be extracted from the nutrients in the cell cultures.

The resulting increase in ion concentration in the nutrients can be prevented by humidifying the air or by using a suitable cover on the cultivation dish.

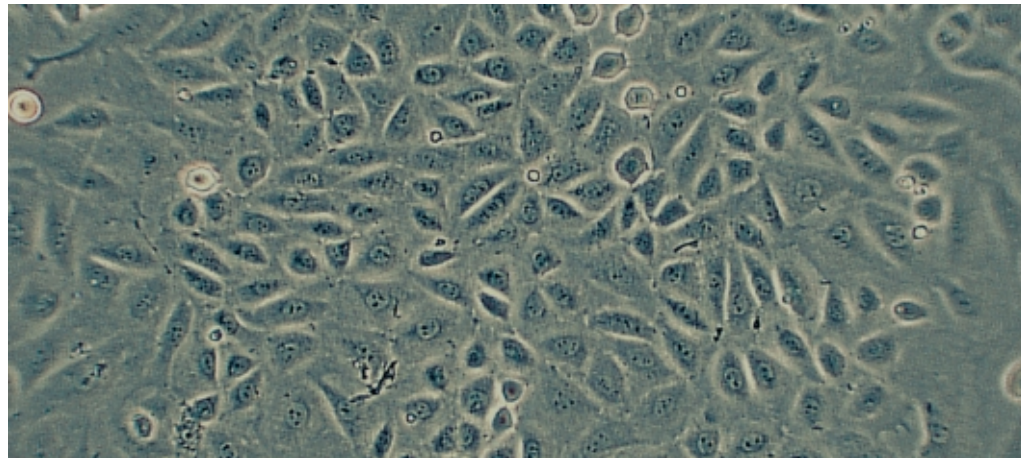

V79 Cells, Chinese Hamster, S. Pentz, Ulm

## Humidifier System

- Efficient humidification of the air
- Special filter pads with large surface area for optimized uptake and delivery of water
- Condensation Vessel for prepreparation



- Increase of the humidity of the air at 37°C to approx. 50% – 70%
- Compatible with incubators S and S-M in combination with CTI-controller or heating unit
- Cat. No. 1116-065

## Humidifier Module (1)

- Increase of humidity with medium flow rates

## Humidifier Module (2)

- Increase of humidity by evaporation from a reservoir vessel



- (1) Included with CO<sub>2</sub> – and O<sub>2</sub>-controller
- (2) Included with incubator M



**FoilCover for Petri Dishes and POC-R Cell Cultivation System**

- Reduces evaporation of water from the medium
- For use with Petri dishes (Ø 35 mm and 60 mm) and for POC-R cell cultivation system (Ø 58 mm) with perfusion possibility
- Sterilizable, gas-permeable
- Essential for "open" cultivations in excess of 6 hrs
- Attainable cultivation period depends on the size of the cultivation chamber; max. 72 hours

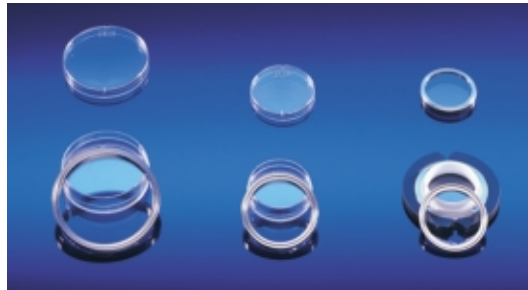

- Compatible with all incubators except incubator S-M
- Components: 2 rings made of V2A ("FoilCover") with fitted 25 µm thick membrane ("CultFoil")
- FoilCover Ø 35 Cat. No. 1116-083
- CultFoil Ø 35 Cat. No. 1116-084
- FoilCover Ø 60 Cat. No. 1116-085
- CultFoil Ø 60 Cat. No. 1116-086
- FoilCover for POC-R Cat. No. 1116-081
- CultFoil for POC-R Cat. No. 1116-082

**FoilCover for Multiwell Dishes**

- Reduces evaporation of water from the medium
- For use with all Falcon® multiwell dishes (6-well, 12-well, 24-well, 96-well)
- Multiple use is possible
- Sterilizable, gas-permeable
- Essential for cultivation periods in excess of 6 hrs
- Attainable cultivation period max. 48 hours

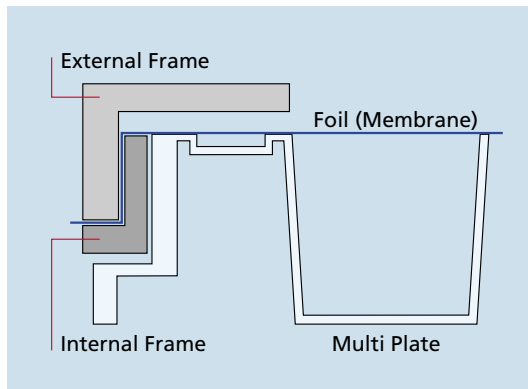

- Compatible with all incubators except incubator S
- Components: 2 frames made of V2A ("FoilCover") with fitted 25 µm thick membrane ("CultFoil")
- FoilCover for multiwell dishes Cat. No. 1156-838
- CultFoil for multiwell dishes Cat. No. 1156-839

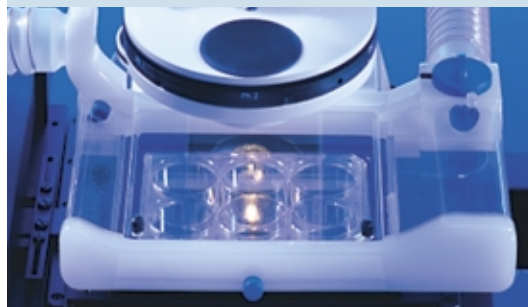



# Control of the O<sub>2</sub> content

Certain cell types are sensitive to the high O<sub>2</sub> content of the ambient air. The O<sub>2</sub> content can be reduced and kept at a constant level during Live Cell Imaging through displacement with nitrogen and the use of specially sealed components. In view of the special demands placed on the components this system is only offered as a complete unit.

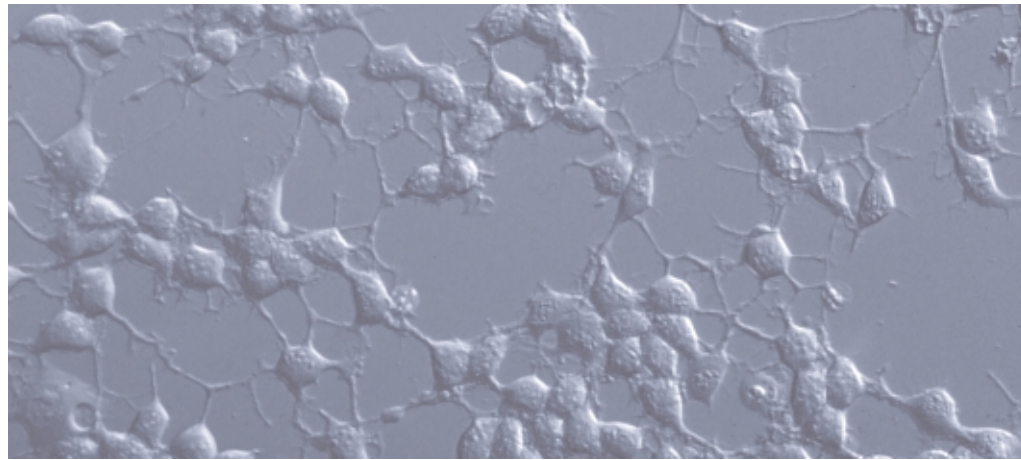

Human hybrid cell line, neuroblastoma- x glia cell, S. Pentz, Ulm

## O<sub>2</sub> Controller

- Only available in the complete system



### O<sub>2</sub> Controller

- O<sub>2</sub> concentration: 20.8 – 1 %
- Special tubing of PU
- O<sub>2</sub> sensor: Zirconiumoxide
- Line connection: 110 – 230 V
- Power consumption: 70 VA
- Dimensions (LxWxH in mm): 270 x 175 x 138
- Weight: 5.0 kg

## Incubation System O<sub>2</sub> - CO<sub>2</sub> - °C

- Controlled reduction of the O<sub>2</sub> concentration through displacement with nitrogen
- FoilCover (recommended) reduces the evaporation of water due to nitrogen
- Assembled from specially sealed and matched components

### Components of the complete system

- O<sub>2</sub> Controller (see above)
- Heating Insert P (see page 5)
- Incubator S (see page 13)
- CTI-Controller (see page 19)
- Tempcontrol 37-2 digital (see page 9)
- Cat. No. of the complete system: 1116-063

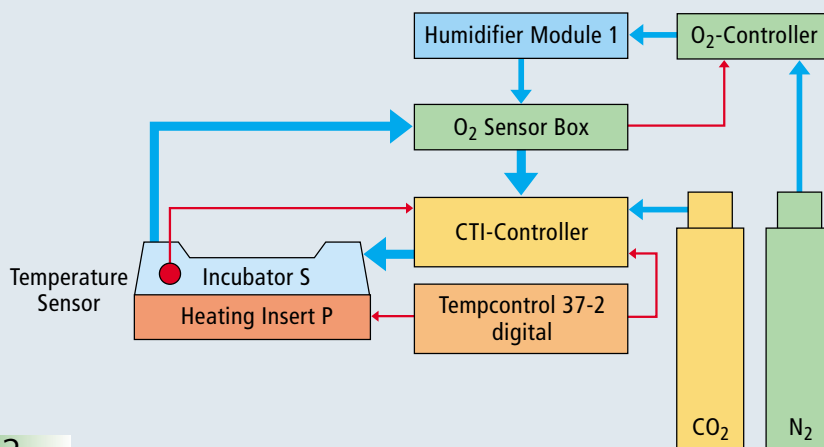

Heating Insert P  
Special version

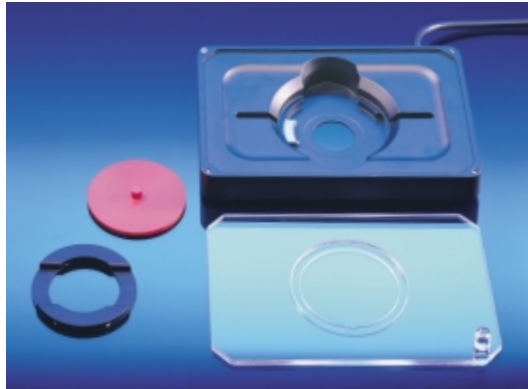

*For full technical specifications  
see page 5*

Incubator S  
Special version

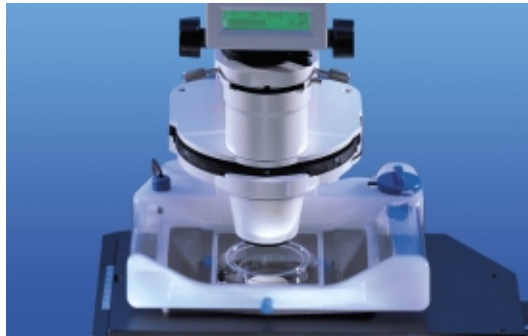

*For full technical specifications  
see page 13*

CTI-Controller  
Special version



*For full technical specifications  
see page 19*

Tempcontrol 37-2 digital  
Special version



*For full technical specifications  
see page 9*

# The cell cultivation systems

State-of-the-art analysis of living cells under the microscope requires special cell cultivation systems. The POC-R cell cultivation and perfusion system meets these requirements, and in addition, offers these major benefits:

- Flexibility for perfusion, open and closed cultivation
- Open perfusion for micromanipulation
- Excellent heat transfer due to aluminum base plate

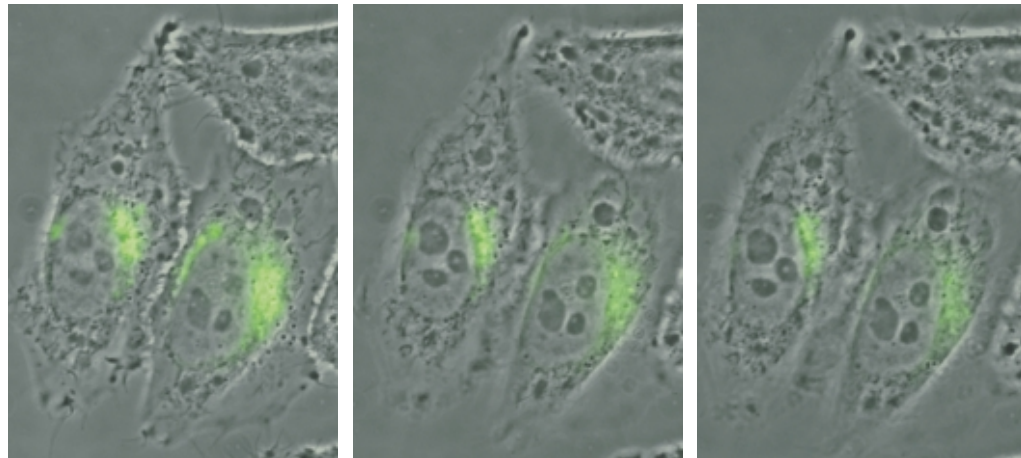

*HeLa Cells, R. Pepperkok, EMBL Heidelberg*

## **POC-R Cell Cultivation System**

- Cell cultivation chamber for closed and open perfusion or closed and open cultivation
- DIC-compatible
- Compatible with high-resolution oil immersion objectives
- POC mini for small cultivation volume – on request

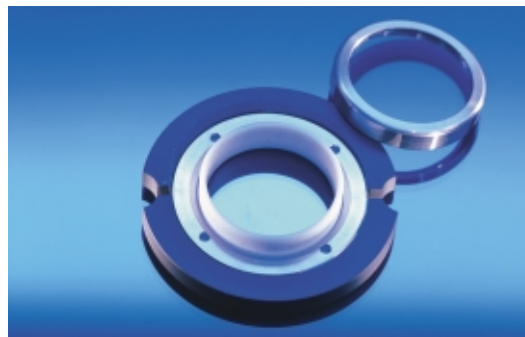

- Aluminum base plate, round, black, anodized
- Dimension:  $\varnothing$  58 x 5.5 mm
- Standard substrate: cover slip  $\varnothing$  42 x 0.17 mm
- Observation area:  $\varnothing$  29 – 32 mm
- Non-toxic materials
- Easy to assemble
- Can be used with all heatable universal mounting frames and the heating insert P
- Weight (kg): 0.027 to 0.039
- Cat. No. 1116-079

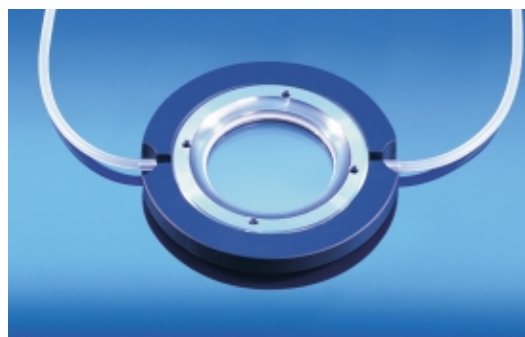
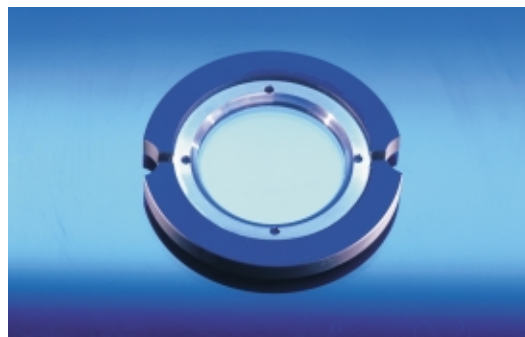

### Open Perfusion Insert POC-R

- Ideal for micromanipulation
- Free access (cover)
- Compatible with high-resolution oil immersion objectives
- DIC-compatible

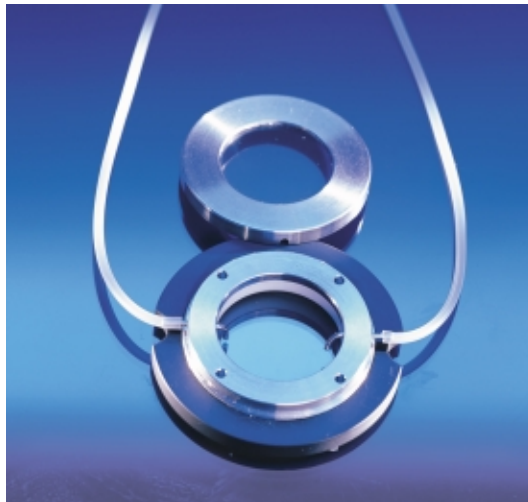

- Accessory to POC-R, screw-on, with low Teflon® insert and V2A ring with glass cover
- Observation area: Ø 29 mm
- Standard substrate: cover glass Ø 42 x 0.17 mm
- Weight (kg): 0.068
- Cat. No. 1116-080

### Multichannel Peristaltic Pump

- Exchange of medium, liquids in the cell cultivation system over a longer period of time
- Excellent delivery and dosage accuracy at low pulsation
- Contact pressure can be individually set
- Four modes of operation: pumping, dosage based on time, dosage based on revolutions, repeated dosage based on time



- Multichannel peristaltic pump with 4 channels
- Used in combination with POC-R cell cultivation system (Cat. No. 1116-079) and POC-R perfusion insert (Cat. No. 1116-080)
- Dimensions (LxWxH in mm): 180 x 150 x 130
- Weight (kg): 4.5
- Line connection 230 V (50 Hz) 115 V (60 Hz)
- Speed regulation: 0 – 45 rot/min, can be digitally set in 1 % increments
- Cat. No. 1116-111



# Frequently asked questions

## Subject: Objective heater

*Why is heating of the objective required?*



Immersion objectives act like a heat sink and a large amount of energy is lost. The other heating devices cannot compensate for this energy loss.

*Is the Tempcontrol-mini absolutely necessary for the use of an objective heater?*



No. The objective heater can also be connected to any free channel of another Tempcontrol unit.

*Can also other heating units be controlled by the Tempcontrol-mini?*



No. The Tempcontrol-mini has been designed exclusively for the low power consumption of objective heaters.

*Will objectives be damaged if a temperature of 40°C is set right from the beginning?*



Heating of the objective occurs slowly. Due to this slow heat transfer the required nominal temperature can be set immediately.

*Where is the measuring sensor positioned in the objective heater?*



The measuring sensor is positioned 0.5 mm behind the inner ring therefore optimal objective protection is guaranteed.



## Subject: Heating stage, Heating frame

*How long does the heating stage require to reach a temperature of 37°C?*



At a room temperature of 22°C, the "warm-up time" normally is about 15 minutes.

*Is a warm air curtain only possible with the heating stage?*



Yes. Additionally, however, polystyrene-foam sleeves which permit an effective insulation of the objective area, are supplied with every heating stage and heatable mounting frame.

*What effect has temperature control with heatable universal mounting frames on the focus of the specimen under observation?*



The design of the laminated heating plates may cause minimal movement of the plates resulting in a focus change. This is evident particularly with high-NA objectives and long exposure times (photography).



## Subject: Incubation

*Why do my cells not survive for a longer period of time although the incubation system appears to function properly?*



### Culture medium:

Usually, cell culture chambers with only a small volume are used for the observation of living cells under the microscope. Due to the metabolic processes in the cell, nutrients in the medium are consumed and toxic metabolic end products created. Especially with high cell populations a frequent change of the medium is recommended. The most effective way is by perfusion of the culture medium in the POC-R cell cultivation system.

### Evaporation of water:

For an optimum gas exchange, the cover of open culture chambers (e.g. Petri dishes) rests loosely on the cultivation vessel. The resulting evaporation and higher ion concentration is undesirable and can be prevented by the use of a humidifier module and/or gas-permeable foil covers (Petri dishes, POC-R cell cultivation system, multiwell dishes).

### Illumination:

Most cell lines are light sensitive even in the visible range. Therefore, constant illumination of the cells during long-term experiments on the microscope should be avoided.

## Subject: Evaporation/air humidity

*How can I prevent the pronounced evaporation of the medium during air temperature control or additional CO<sub>2</sub> control?*



An improvement can be achieved through the use of a humidifier system or module and of a gas permeable FoilCover (Petri dishes, POC-R cell cultivation system, multiwell dishes).

*How can condensation at the surface of Petri dishes be prevented?*



With a heated air current whose temperature lies slightly (1–2°C) above the nominal temperature of the specimen/medium. This can be optimally achieved in an incubator.

*Is the gas-permeable membrane (FoilCover) sterilizable?*



The membrane mounted in the carrier rings is sterilizable for 2 hours at +165°C.

*Which incubation system is ideal for long-term experiments?*



Incubator S with heating insert P is especially suited for long-term experiments.

*Can the incubator S also be used with the heating inserts M06...96, or the Incubator S-M with the heating insert P?*

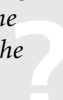

No. This is unfortunately not possible due to the different outer dimensions of the heating inserts (multiwell dishes).

# Choosing the right components - Your guide for selecting the optimum system for your application

The components for temperature control and incubation described in this brochure offer a wide selection of possibilities. There are suitable components for every application irrespective of complexity.

Providing the answers to the adjacent questions will assist you to select the best combination for your application.

## **1. What performance do you expect?**

- Simple and budget-priced solution
- Universal and flexible solution
- Exacting/versatile solution for long-term experiments

## **2. What specimen vessels will be predominantly used?**

- Group A: Petri dishes (Ø 35 and 60 mm), POC-R cell cultivation system, LabTek chambered slides, slides
- Group B: Petri dishes (Ø 35 and 60 mm), POC-R cell cultivation system, LabTek chambered slides, slides, Microtiter plates
- Group C: Falcon® Multiwell dishes (M06, M12, M24, M96)

## **3. What are the essential microscope components?**

- Stage (stage plate, mechanical stage, scanning stage)
- Condenser (LD condensers, high-aperture condensers)
- Objectives (LD objectives, oil immersion objectives)

## **4. Must the components be compatible with external components?**

- Manipulators, tools (pay attention to type of fixtures)
- Other external accessories

The following 11 examples may assist you in selecting the optimum configuration. Depending on your application they can be expanded or simplified.

# Examples

## Temperature control 37°C

### Budget priced solution

Culture chambers: Group A\*

Requirement: Object guide

Microscopes: Axiovert 25, 100, 135, 200

Expandable with:

Objective heater matching the objective,  
Pre-heating plate # 471841-9902,  
TempControl 37-2 digital # 1052-320

Options:

Heatable Universal Mounting Frame K-H  
# 1116-056, or KH-L # 1005-837

for Mechanical or Scanning stages for  
Axiovert 100, 135, 200.

Or, for upright microscopes: Heatable  
Universal Mounting Frame A-H # 1116-055

### Universal solution

providing optimal temperature conditions

Culture chambers: Group B\*\* (with Universal  
Mounting Frame M), Group C\*\*\* (with  
Universal Mounting Frame M-X)

Requirement: Object guide

Microscopes: Axiovert 200

Expandable with:

Pre-Heating Plate with 3 Inserts # 1116-049,  
Tempcontrol 37 (1-channel) # 1116-057

Options: Air Circulation Generator

# 471824 (220 V) or # 471823 (110 V) for  
a warm air curtain instead of an Objective  
Heater, Heating Insert for Transmitted  
Light Illumination # 411862-9901

### Demanding solution

Provision for perfusion, long-term stability,  
good temperature conditions, good optical  
quality

Culture chambers: Group A\*

Requirement: Mechanical or Scanning Stage

Microscopes: Axiovert 100, 135, 200

Expandable with:

Pre-Heating Plate with 3 Inserts # 1116-049,  
Tempcontrol 37 (1-channel) # 1116-057,  
Perfusion Insert for POC-R # 1116-080,  
Multichannel Peristaltic Pump # 1116-111  
for perfusion

Options: Heating Insert M (06/12/24/96)  
# 1116-0(50/51/52/53) instead of Heating  
Insert P.

Note: Heating Insert M is not compatible  
with condenser 0.55

### Example 1

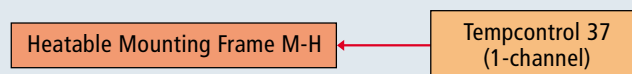

*Cat. Nos.:*

*Heatable Mounting Frame M-H # 1116-054*

*Tempcontrol 37 (1-channel) # 1116-057*

### Example 2

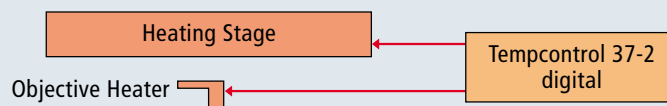

*Cat. Nos.:*

*Heating Stage # 1116-048*

*Objective Heater matching the objective*

*Tempcontrol 37-2 digital # 1052-320*

### Example 3

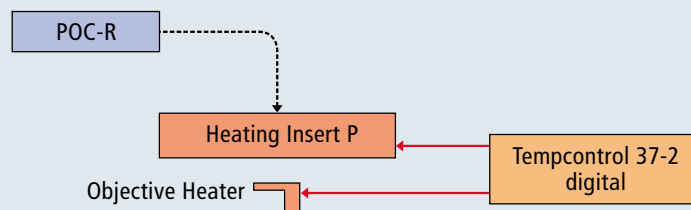

*Cat. Nos.:*

*POC-R Cell Cultivation System # 1116-079*

*Heating Insert P # 411861-9901*

*Objective Heater matching the objective*

*Tempcontrol 37-2 digital # 1052-320*



# Examples

## Temperature control 37°C

### Flexible solution

In conjunction with micromanipulation, stable temperature conditions

Culture Chambers: Group A\*

Requirement: Object guide

Microscopes: Axiovert 200

Expandable with:

Pre-Heating Plate with 3 Inserts # 1116-049,  
Tempcontrol 37 (1-channel) # 1116-057

Options: different Heatable Mounting Frames,  
Heating Insert P # 411861-9901,  
Heating Insert M (06/12/24/96)

# 1116-0(50/51/52/53) for Multiwell Dishes.

Note: The requirements for Mounting Frames  
and Heating Inserts (Examples 1+3) should  
be taken into account

### Example 4

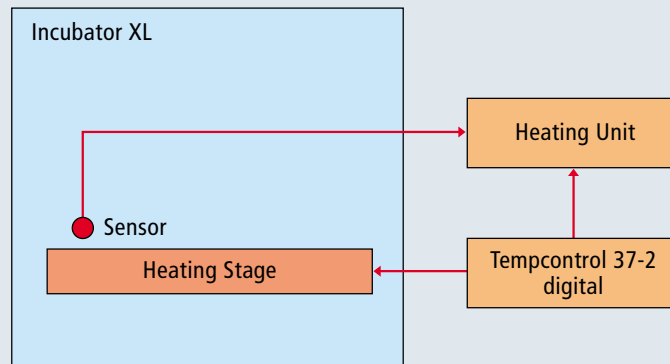

*Cat. Nos.:*

*Incubator XL # 1116-059*

*Heating Stage # 1116-048*

*Heating Unit # 1116-061*

*Tempcontrol 37-2 digital # 1052-320*

The incubator XL is only compatible with Axiovert 200. Objective heater and air circulation generator are not required. Later upgrade for CO<sub>2</sub> regulation is possible.

## Temperature control 0°C - 65°C

### Universal temperature control

From 0°C – 65°C (i.e. for blastomere biopsy)

Culture Chambers: Group B\*\* (with Universal Mounting Frame M), Group C\*\*\* (with Universal Mounting Frame M-X)

Requirement: Object Guide and Universal Mounting Frame M or M-X

Microscopes: Axiovert 200

Expandable with:

Temperable Plate # 1116-067

Options: Temperable Insert for Transmitted Light Illumination # 411883 (for stereomicroscopes)

### Universal temperature control

From 0°C – 65°C, with perfusion, good optical quality

Culture Chambers: Group A\*

Requirement: Mechanical or Scanning Stage

Microscopes: Axiovert 100, 135, 200

Expandable with:

Temperable Plate # 1116-067,

Perfusion Insert # 1116-080, Multichannel

Peristaltic Pump # 1116-111 for perfusion

### Example 5

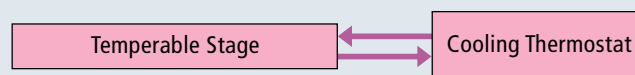

*Cat. Nos.:*

*Temperable Stage # 1116-066*

*RE 106 Cooling Thermostat (230 V) # 1116-068*

### Example 6

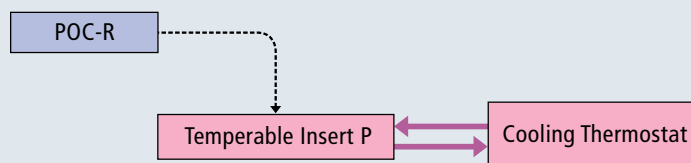

*Cat. Nos.:*

*POC-R Cell Cultivation System # 1116-079*

*Temperable Insert P # 411882*

*RE 106 Cooling Thermostat (230 V) # 1116-068*

# Examples

## Temperature control 37°C and control of the pH-value

### System for exacting demands

Long-term experiments (72 hrs) with FoilCover, very stable temperature conditions, efficient humidification

Culture Chambers: Group A\*

Requirement: Mechanical or Scanning Stage

Microscopes: Axiovert 100, 135, 200

Expandable with:

Objective Heater matching the objective, Pre-Heating Plate with 3 Inserts # 1116-049, Tempcontrol 37-2 digital # 1052-320, Perfusion Insert # 1116-080 and Multichannel Peristaltic Pump # 1116-111 for perfusion.

Options: Heating Unit # 1116-061 instead of CTI-Controller (warm-air incubation only!)

### System for exacting demands

Long-term experiments (48 hrs) with FoilCover, very stable temperature conditions, efficient humidification

Culture Chambers: Group C\*\*\*

Requirement: Mechanical or Scanning Stage, Condenser 0.35 (Condenser 0.55 is not compatible), only for use with LD Objectives (Immersion Objectives and therefore) also Objective Heaters, are not compatible)

Microscopes: Axiovert 100, 135, 200

Expandable with:

Pre-Heating Plate with 3 Inserts # 1116-049, Tempcontrol 37 (1-channel) # 1116-057

Options: Heating Unit # 1116-061 instead of CTI-Controller (warm-air incubation only!)

### Single-sided micro-injection

for use with Eppendorf InjectMan (# 5179.000.018) for adherent cells, efficient humidification

Culture Chambers: Group B\*\*\*

Requirement: Object Guide and Universal Mounting Frame M or M-X (Condenser 0.55 mot. is not compatible)

Microscopes: Axiovert 100, 135, 200

Options: version for right-hand manipulator mounting on request, Heating Unit # 1116-061 instead of CTI-Controller (warm-air incubation only!), Air Circulation Generator # 471824 (230 V) or # 471823 (110 V) to provide a warm air curtain instead of an Objective Heater and Tempcontrol-mini

### Example 7

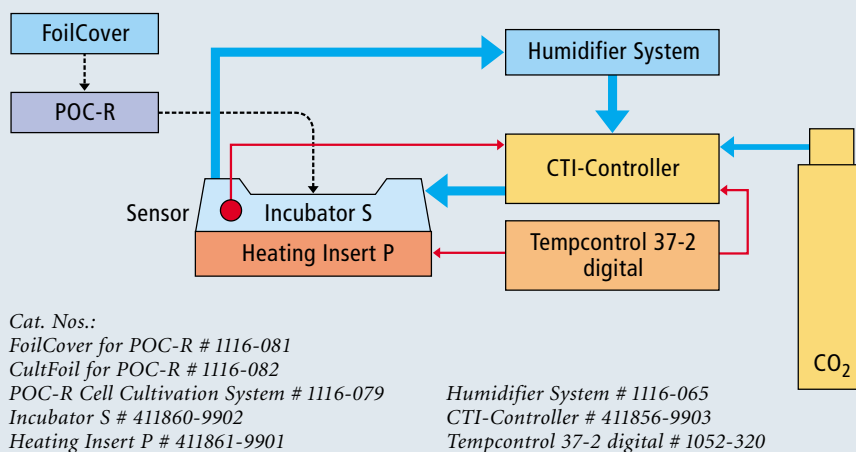

### Example 8

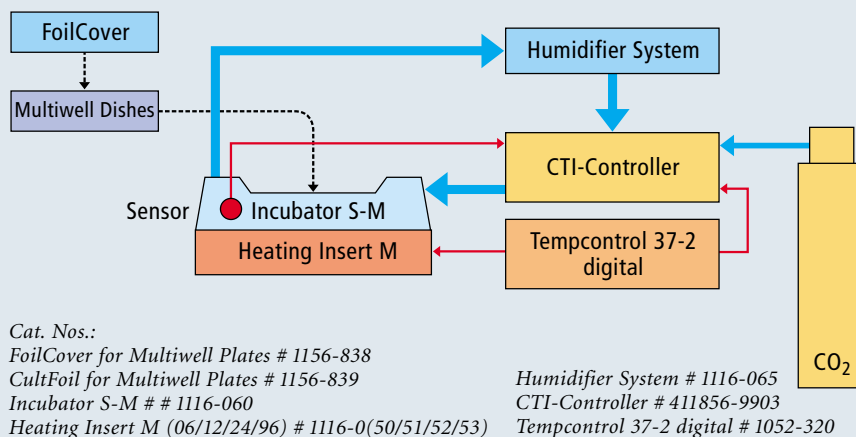

### Example 9

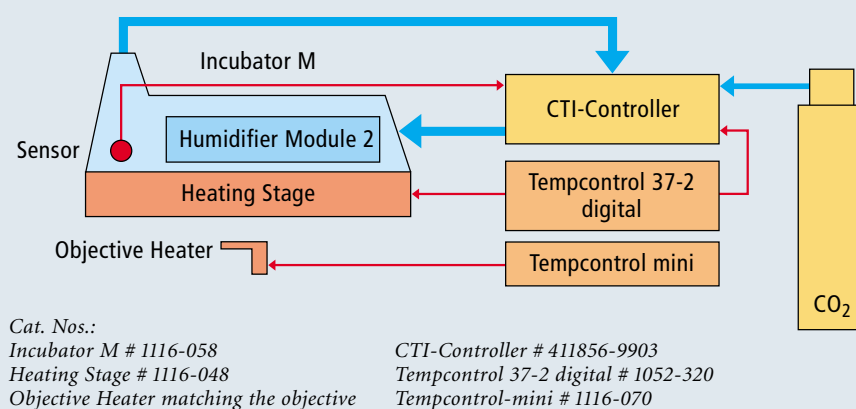

# Examples

## Temperature control 37°C and control of the pH-value

### Flexible system for exacting demands for micromanipulation

For long-term experiments, very stable temperature conditions, efficient humidification

Culture chambers: Group A\*

Requirement: Object Guide

Microscopes: Axiovert 200

Options: Heatable Mounting Frame M-H # 1116-054.

Heating Insert P # 41186-9901 and Heating Insert M (06/12/24/96) # 1116-0(50/51/52/53)

Note: CO<sub>2</sub> Covers for Heatable Mounting Frame M-H and Heating Inserts P and M on request, Heating Inserts are compatible only with Mechanical or Scanning Stage, also see requirements for Heatable Mounting Frames in Examples 1+3

### Example 10

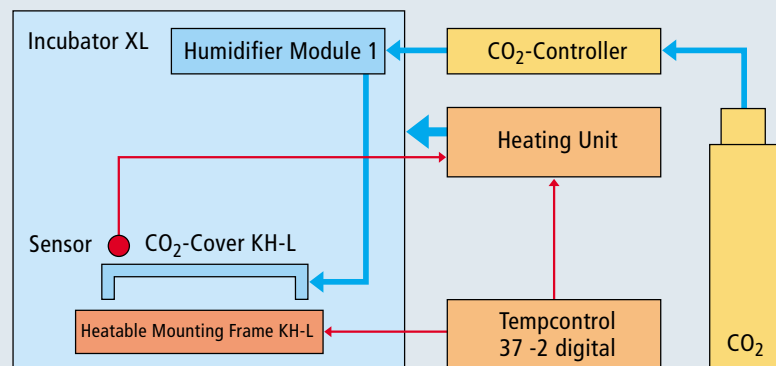

*Cat. Nos.:*  
 Incubator XL # 1116-059  
 Heatable Mounting Frame KH-L # 1005-837  
 CO<sub>2</sub>-Controller and accessories # 1116-062  
 Heating Unit # 1116-061  
 Tempcontrol 37-2 digital # 1052-320

The incubator XL is only compatible with Axiovert 200. Objective heater and air circulation generator are not required.

## Temperature control 37°C, control of the pH-value and O<sub>2</sub> concentration

### Complete system for the control of all parameters

Long-term experiments (48 hrs) with FoilCover, good optical quality

Culture Chambers: Group A\*

Requirement: Mechanical or Scanning Stage

Microscopes: Axiovert 100, 135, 200

Expandable with:

Objective Heater matching the objective, Pre-Heating Plate with 3 Inserts # 1116-049, Tempcontrol 37-2 digital # 1052-320, Perfusion Insert # 1116-080 and Multi-channel Peristaltic Pump # 1116-111 for perfusion

### Example 11

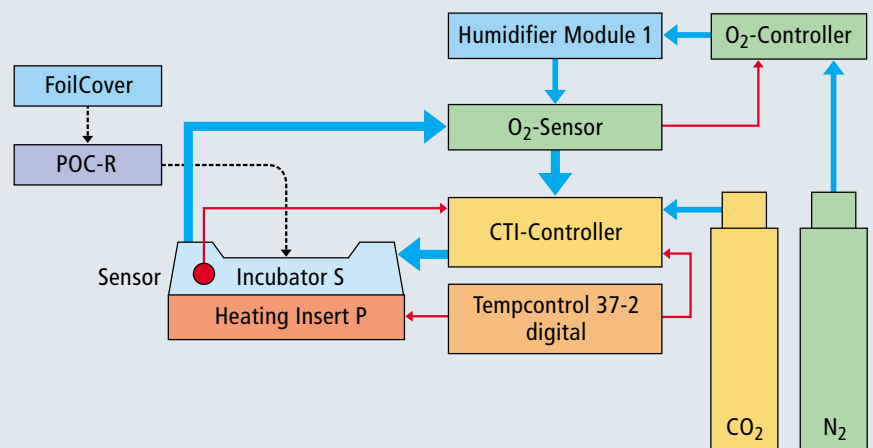

*Cat. Nos.:*  
 Incubation System O<sub>2</sub>-CO<sub>2</sub>-°C # 1116-063  
 FoilCover for POC-R # 1116-081  
 CultFoil for POC-R # 1116-082  
 POC-R Cell Cultivation System # 1116-079

Due to the need for special components, incubation system O<sub>2</sub>-CO<sub>2</sub>-°C # 1116-063 is only available as a complete system.

\*Group A: Petri dishes Ø 35 and 60 mm, POC-R Cell Cultivation System, LabTek chambered slides, slides

\*\*Group B: Petri dishes Ø 35 and 60 mm, POC-R Cell Cultivation System, LabTek chambered slides, slides, Microtiter plates

\*\*\*Group C: Falcon® Multiwell plates (M06, M12, M24, M96)

# The complete solution for Live Cell Imaging: Cell Observer

The Cell Observer is a combination of perfectly matched components from Carl Zeiss for the observation and documentation of dynamic processes in living cells or tissue.

The following applications can be freely combined: time lapse, multichannel, Z-stacks and Mark & Find.

Application-specific solutions for the control of temperature-, pH-value ( $\text{CO}_2$ ) and oxygen ( $\text{O}_2$ ) complete the system and provide optimum living conditions on the microscope – essential for the documentation of dynamic processes in long-term experiments.

## The Components

### Axiovert 200 or Axiovert 200 M Microscope

- Global standards in high-end microscopy
- Superb optics and fluorescence
- Superior flexibility, stability and ergonomic design

### AxioCam Digital Camera

- Cooled digital camera – color or B/W
- Brilliant for every application
- Highest resolution up to 3900 x 3090 pixels

### AxioVision Software

- Powerful software solution from Carl Zeiss
- Automatic control of microscope, camera, x-y stage and multidimensional images
- Efficiently structured, with all the major modules

### Cell Cultivation

- Precise control of temperature,  $\text{CO}_2$  and  $\text{O}_2$  and reduced evaporation
- Large selection of x-y stages, incubators, cell cultivation and perfusion chambers
- Guaranteed optimal and constant living conditions for cells and tissues

## The Applications

- Observation over time in up to 5 channels (fluorescence and transmitted light)
- Observation over time in up to 5 channels with interruption and manipulation
- Observation over time in up to 5 channels with motorized x-y stage
- Observation over time in up to 5 channels with Z-stacks

**2D**  
**x + y**



**3D**  
**x, y + z**

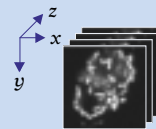

**4D**  
**x, y, z + λ**

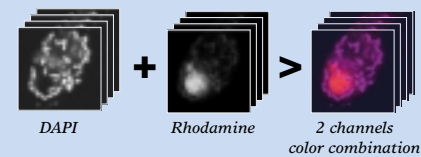

**5D**  
**x, y, z, λ + t**



**6D**  
**x, y, z, λ, t**  
**+ various positions**

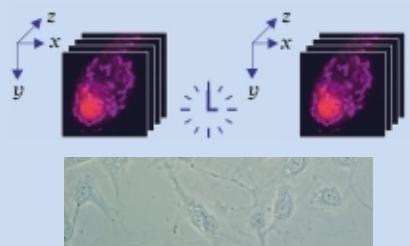



# You need more information?

The brochure mentions other products from Carl Zeiss.

Of course you can get detailed information, also in other languages.

Interested?

Simply order today!

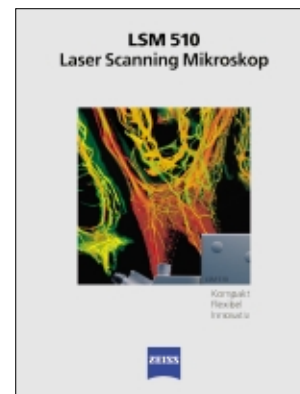
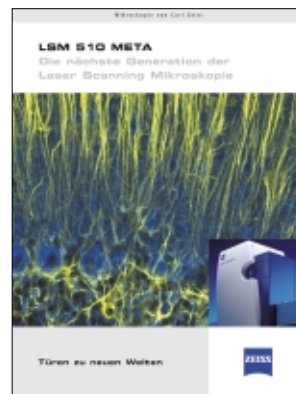
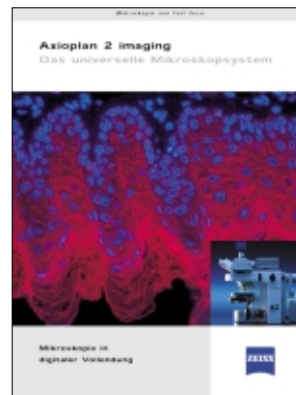
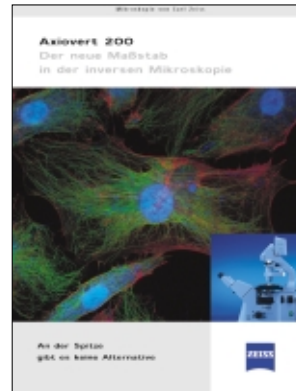

## Carl Zeiss Light Microscopy

P.O.B. 40 41  
37030 Göttingen  
GERMANY  
Phone: ++49 5 51 50 60 660  
Telefax: ++49 5 51 50 60 464  
E-Mail: [micro@zeiss.de](mailto:micro@zeiss.de)

[www.zeiss.de/micro](http://www.zeiss.de/micro)

Design and specifications are subject to change in the interest of technical development

40-811 e/03.02

Printed on environment-friendly paper,  
bleached without the use of chlorine.

# NOTES ON THE PDF FILE

## VIEW

When paging through the PDF file, as a rule you will see one page on your screen at a time.

If you wish to see two facing pages of a catalog at a time, please activate the "Continuous - Facing Pages" item in the "View" menu of Acrobat Reader.

## PRINTING

The pages of the PDF file are sized 210 x 277 mm.

Please mind that your printer may not print the page area from edge to edge.

To avoid picture cropping, please change the print size. We recommend 95%.

The area to be printed is framed by black lines on every page of this PDF file.